

Common Electronic Symbols

power $\uparrow +9V$   Ground

Capacitors

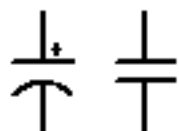

Unit of capacitance is a Farad (F)

Resistor



Unit of resistance is an Ohm (Ω)

Transistors

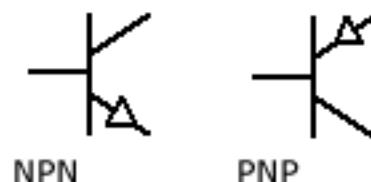

N-channel FET

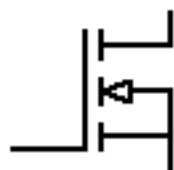

Diode and Light Emitting Diode

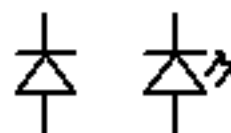

speaker

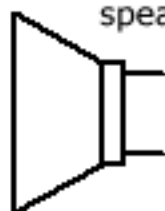

Motor



Voltage Regulator

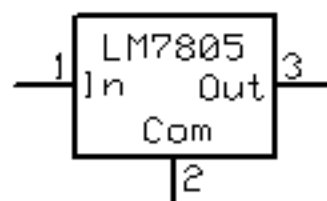

Common Switch Names

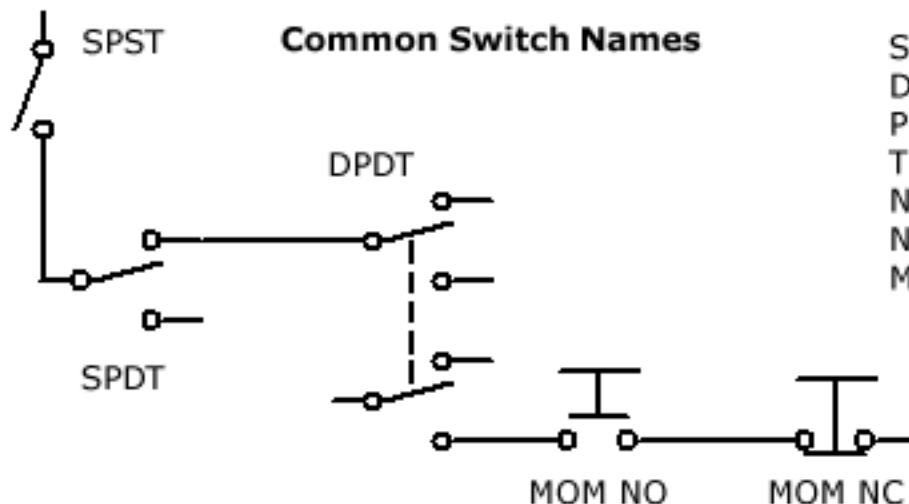

S - single
 D - double
 P - pull
 T - throw
 NC - normally closed
 NO - normally open
 MOM - momentary